

Article number: 20191B10B102BL

Description: E+G

T-angle clamps GN191-B10-B10-22-BL

Measures

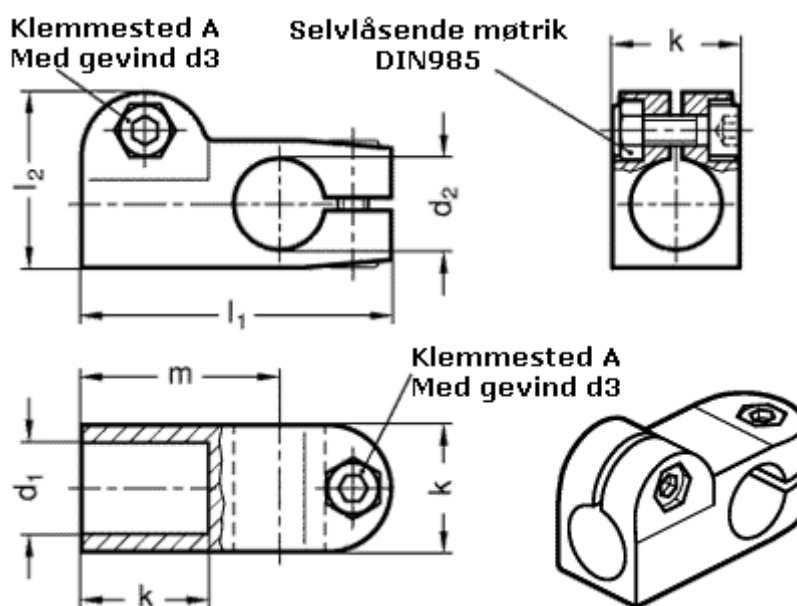

d1 = B10
d2 = B10
d3 = M 6
k = 25
l1 = 61
l2 = 34.5
m = 39